

Autonics Weekly/Yearly Timer LE365S-41

MANUAL



Thank you very much for selecting Autonics products.
For your safety, please read the following before using.

Caution for your safety

- Please keep these instructions and review them before using this unit.
- Please observe the cautions that follow:
 - Warning** Serious injury may result if instructions are not followed. Product may be damaged, or injury may result if instructions are not followed.
 - Caution** The following is an explanation of the symbols used in the operation manual.
 - Injury or danger may occur under special conditions.

Warning

- In case of using this unit with machinery(Nuclear power control, medical equipment, vehicle, train, airplane, combustion apparatus, entertainment or safety device etc), it is required to install fail-safe device.** It may cause a fire, human injury or damage to property.
- It should be mounted on Panel to use.** It may give an electric shock.
- Do not connect, inspect and repair when power is ON.** It may give an electric shock.
- Do not disassemble or modify this unit. Please contact us if it is required.** It may give an electric shock and cause a fire.
- Lithium battery is used for memory protection in this product, therefore do not disassemble or burn up. Please contact Autonics to replace battery.** It may cause an explosion.
- Safe using for battery** This battery has combustibles including lithium organic solvent, it may cause a fire, exothermicity, leakage and explosion, please keep the following.
 - Do not charge, short, disassemble, transform, heating and throw in a fire.
 - Do not solder on a battery directly.

Caution

- This unit shall not be used outdoors.** It might shorten the life cycle of the product or give an electric shock.
- Please use power input terminal wire over AWG NO. 20(0.50mm²), relay output terminal wire over AWG NO. 14(2.50mm²) and tighten terminal screw with 0.74-0.90N·m strength.** It may cause a malfunction or fire due to contact failure.
- Please observe the rated specifications.** It might shorten the life cycle of the product and cause a fire.
- In cleaning the unit, do not use water or an organic solvents.** It may give an electric shock and fire.
- Do not use this unit at place where there are flammable or explosive gas, humidity, direct ray of the sun, radiant heat, vibration and impact etc.** It may cause a fire or explosion.
- Do not inflow dust or wire dregs into the unit.** It may cause a fire or malfunction.

Ordering information

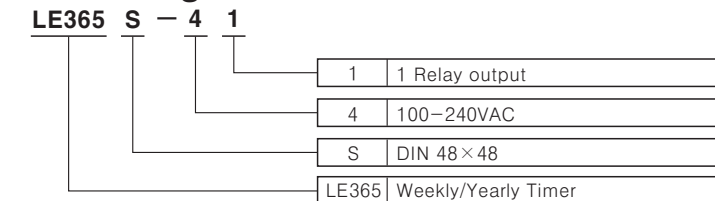

Connections

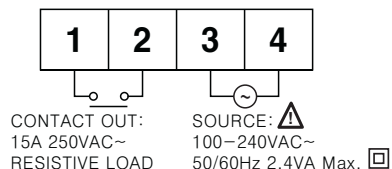

*The above specifications are subject to change without notice.

Front panel identification

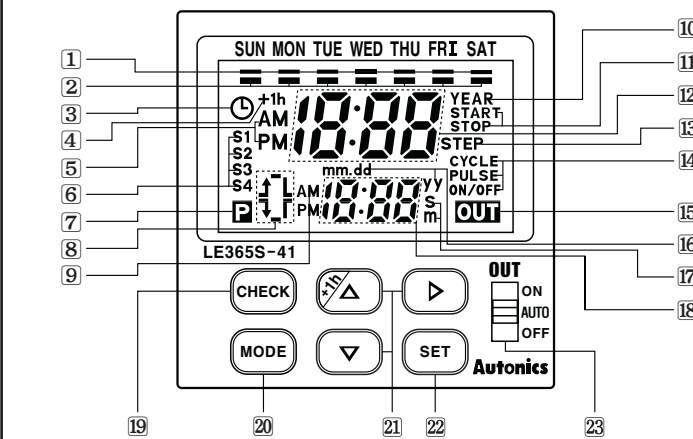

- Day indicator**
- Day display**
 - Light : Day is selected.
 - Light-out : Day is not selected.
- Current time setting mode indicator**
- DST display(Daylight Saving Time)**
- AM/PM display(Main display)**
- Season display**
- Program display**
- Display ON time/day, OFF time/day, ON time width, OFF time width**
- AM/PM display(Sub-display)**
- YEAR display** : It is lighted when set, check, modify, delete yearly program, set yearly holidays and operate yearly program.
- Yearly START/STOP day display**
- Main display**
- Remaining step display**
- Operation mode display**
- Output mode display**
- Year, month, date display**
- Unit of pulse duration display**
- Sub-display**
- CHECK Key**
- MODE Key**
- Operation key** : Press [+1h] key over 3sec in RUN mode, DST mode is set and released.
- SET Key**
- Output selection switch**
 - AUTO : Control output according to the set program.
 - ON : Output is ON.(Operation)
 - OFF : Output is OFF.

Dimensions & Mounting

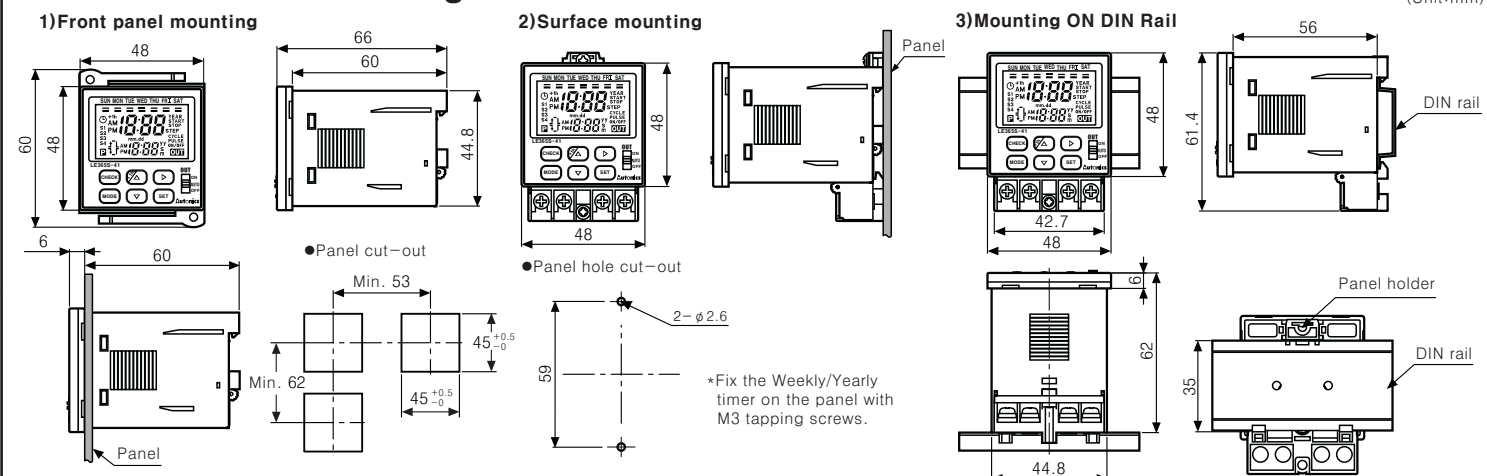

4)How to switch from the flush mounting to surface or DIN rail mounting type

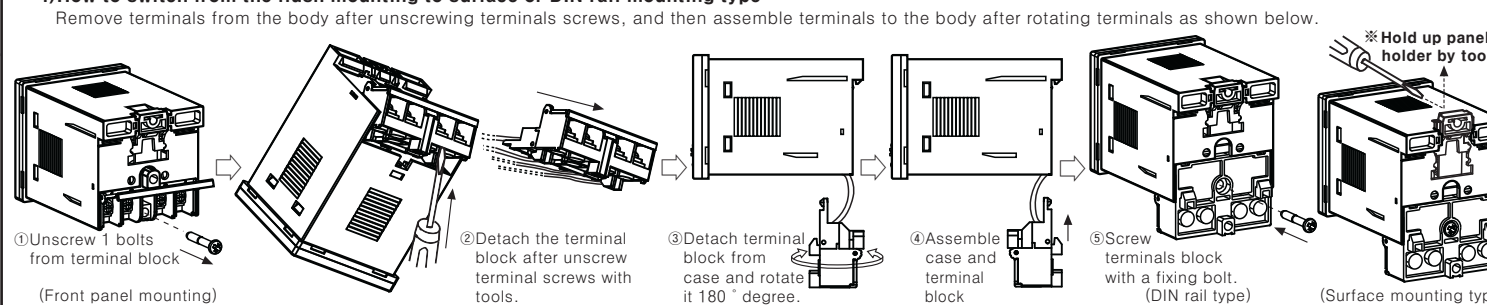

Specifications

Model	LE365S-41
Power supply	100-240VAC 50/60Hz
Allowable voltage range	90 to 110% of rated voltage
Power consumption	Max. 2.4V
Control	Contact type SPST(Single Pole Single Contact)
Output	Contact capacity 250VAC 15A resistive load
	Number of circuits Independent 1 circuits(1a)
Number of steps	48 steps for weekly, 24 steps for yearly
Operation mode	ON/OFF mode, Cycle mode, Pulse mode
Mounting	Front panel mounting, Surface mounting, DIN rail mounting
Time deviation	±15sec/month(Ta:25°C)
Temperature error	0.01% ±0.05sec
Memory protection	Over 5 years(25°C)
Insulation resistance	Min. 100MΩ(at 500VDC)
Dielectric strength	2000VAC 50/60Hz for 1 minute
Noise strength	±2kV the square wave noise(pulse width:1μs) by the noise simulator
Relay life cycle	Mechanical Min. 5,000,000 operations(Switching capacity 30 times/1 minute)
	Electrical 50,000 operations(Switching capacity 20 times/1 minute, at 250VAC 15A(resistive load))
Ambient temperature	-10 ~ +55°C(at non-freezing status)
Ambient humidity	35 ~ 85%RH
Storage temperature	-25 ~ +65°C(at non-freezing status)
Approval	CE, VDE
Unit weight	Approx. 110g

Functions

- Definitions**
 - Record : A part of program that controls output operation.
 - Step : Basic component of Record.
- Operation mode**
 - If the operation mode of Program1 (Program2) is set on Pulse mode initially, the Pulse mode is fixed for additional programs.
- Weekly ON/OFF mode**
 - Output operation by ON/OFF set time.
 - Min. time setting unit : 1 min.
 - Able to set ON/OFF day separately.
 - One Record in two Steps (ON day/ON time, OFF day/OFF time)
- Weekly Cycle mode**
 - Output turns ON for ON time and turns OFF for OFF time. And the ON/OFF cycle is repeated.
 - Range of ON/OFF time : 1 min.~12:59
 - One Record in three Steps(ON day/ON time, OFF day/OFF time, ON width/OFF width)
- Weekly Pulse mode**
 - Output turns ON at ON time for a specified pulse width. (Pulse width : 1~59sec, 1~60min)
 - One Record in two Steps(ON day/ON time, Pulse width)
- Yearly ON/OFF mode**
 - Output turns ON at ON time on START date and turns OFF at OFF time on STOP date.
 - One Record in three Steps(START/STOP date, ON/OFF time)
- Yearly Pulse mode**
 - Output turns ON at ON time on START date and turns OFF at OFF time on STOP time for a specified pulse width repeatedly.
 - One Record in three Steps(START/STOP date, ON time, Pulse width)

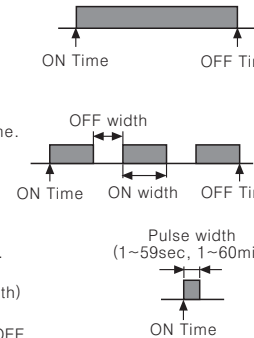

Program operation

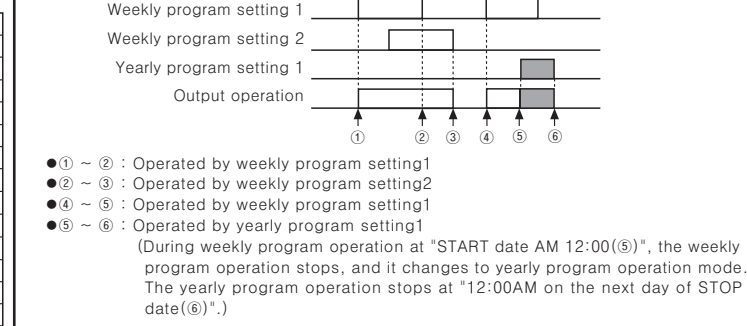

- Display and change of next mode**
 - The day of next mode in program is displayed on the day indicator, and the time of next mode is displayed on the lower row of screen.
 - In ON/OFF or Cycle mode, set ON time and OFF time to next mode. In Pulse operation mode, set Pulse ON time to next mode.

- Power restore mode**
 - In setting group 2—"LEVEL 2" ("rEL" is lighted, "RL" or "nor" are flashed), select Auto("RL" or Normal("nor") by [▲] or [▼] keys and press [SET] key to set.
 - Auto("RL") power restore mode
 - Output(OUT1, OUT2) operates according to program when power turns on again after power failure.
 - Normal("nor") power restore mode
 - When power turns on again after power failure, output is kept OFF and "r:n" is flashed on the lower row of screen and power restore input(press [SET] key over 3 sec., in RUN mode) is applied, "r:n" is light out and output operates according to program.

- Season switching mode**
 - In setting group 2—"LEVEL 2" ("SEn" is lighted, "oFF" is flashed.), select ON("on") by [▲] or [▼] keys and press [SET] key to set.
 - (Note) : When the season switching mode changed from "oFF" to "on" or vice versa, previous set programs are deleted.
 - ON("on") mode
 - Weekly program is switched automatically by season switching.
 - Period setting per season
 - Press [SET] key in period setting per season mode of setting group 2. ("SEn" is flashed, season with preset period is lighted and "START" and "STOP" are lighted.)
 - Advance to the flashing position of season selection among S1, S2, S3, S4 by [▲] or [▼] keys and press [SET] key.
 - After set START month, date per season and press [SET] key.
 - [SET] key is pressed after set STOP month, date per season, it is advanced to LEVEL1 of period setting per season. Add or adjust the period setting by [SET] key.
 - It is disable to use when it is OFF("oFF").

- Daylight Saving Time**
 - In setting group 2—"LEVEL 2" ("dSt" is lighted, "RL" or "nor" is flashed.), select Auto("RL" or Normal("nor") by [▲] or [▼] keys and press [SET] key to set.
 - Auto("RL") Daylight Saving Time mode
 - Current time will be faster as an hour when it is started and will be slower as an hour when Auto mode is finished.
 - Automatic Daylight Saving Time period setting
 - Automatic Daylight Saving Time period setting LEVEL 1 of setting group 2. ("dSt" is flashed and "START" and "STOP" are lighted.)
 - Set START date(Month, date) of automatic Daylight Saving Time mode and press [SET] key. But, the minute will be fixed as 00.
 - Set STOP date(Month, date) of automatic Daylight Saving Time mode and press [SET] key.
 - Set STOP time(AM/PM, Hour) of automatic Daylight Saving Time mode and press [SET] key. But, the minute will be fixed as 00.
 - Normal("nor") Daylight Saving Time mode
 - Press [+1h] key over 3sec in RUN mode, "+1h" is lighted and current time is faster as an hour and "+1h" is lighted out, current time will be slower as an hour when press [+1h] key over 3sec again.

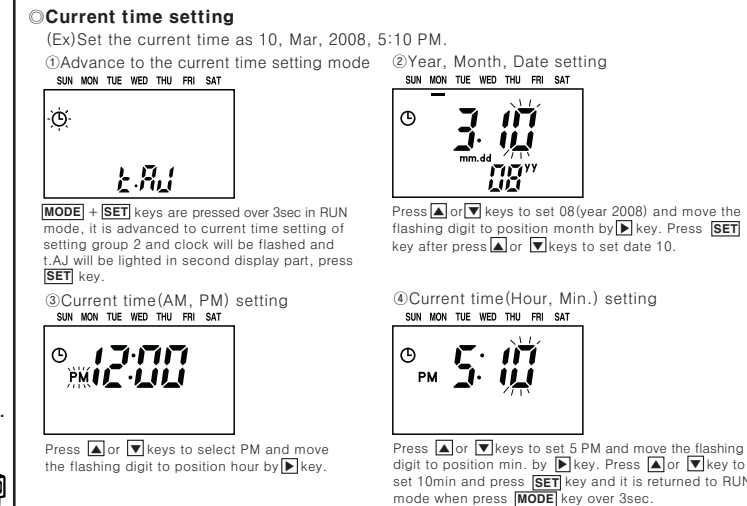

- It advances to "①Current time setting mode" in ON status and set current time as shown above ②~④ by [SET] key.
- Current time is set up to 31, Dec, 2099.
- Check current year/month/date in RUN mode
 - When [▶] key is pressed over 3sec in RUN mode, it advances to current year/month/date display. After display current year/month/date for 3sec, it returns to RUN mode displaying current display.

Program setting

Setting group 1

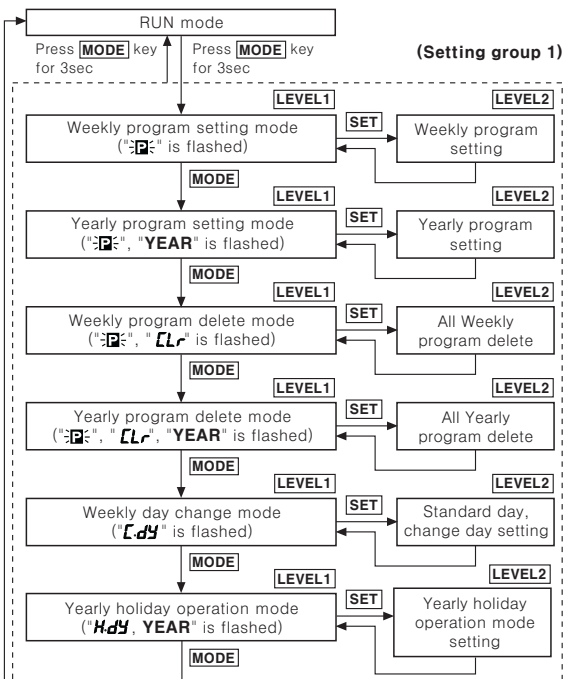

- When it is advanced to setting group 1 in RUN mode, output (OUT1, OUT2) will be OFF.
- It is returned to previous setting group 1 when power of time switch is ON again in setting group 1.
- When [MODE] key is pressed in LEVEL2 of setting group 1, current setting will be canceled and it is returned to previous LEVEL1.
- When press [SET] key to program over max. number of steps for weekly program in Weekly program setting mode of setting group 1-LEVEL 1, number of remaining steps and "STEP" are flashed and it returns to LEVEL 1 status.
- When press [SET] key to program over max. number of steps for yearly program in Yearly program setting mode of setting group 1-LEVEL 1, number of remaining steps and "STEP" are flashed it returns to LEVEL 1 status.

Setting group 2

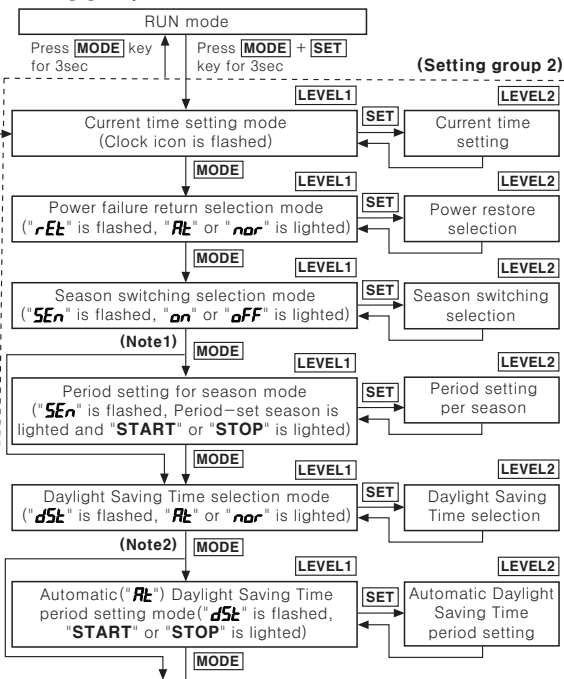

- (Note1) Season switching selection is "off".
- (Note2) Automatic switching selection of Daylight Saving Time is Normal ("nor").
- When it advances to setting group 2 in RUN mode, output(OUT1, OUT2) will be OFF.
- When power of time switch is ON again in setting group 2, it is returned to previous setting group 1.
- Front [MODE] key is pressed in LEVEL2 of setting group 2, it is returned to previous LEVEL1.
- When season switching selection is changed from "off" to "on" or "on" to "off", previous set weekly program will be deleted.

Weekly program setting

Weekly ON/OFF mode

(Ex)Output1(OUT1) is ON from Monday to Friday at 8:00 AM and OFF at 6:10 PM.

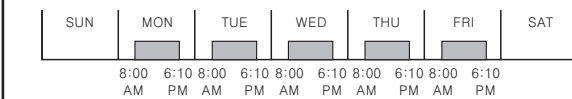

- Advance to weekly program setting mode
- Mode type setting
- ON day setting

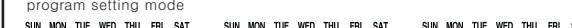

- [MODE] key is pressed over 3sec in RUN mode, [P] is flashed and press [SET] key.
- Press [SET] key in ON/OFF mode.
- Press [P] key to move the indicator to Monday, it will be lighted when [A] or [V] keys are pressed and move it to Tuesday by [P] key. Press [SET] key after Tuesday, Wednesday, Thursday, Friday are lighted.

- ON time setting (AM, PM)
- ON time setting (Hour, Min.)
- OFF day setting

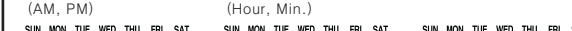

- [P] key is pressed, move the flashing to hour position and select PM by [A] or [V] keys when ON time is afternoon.
- Set 8:00 by [A] or [V] keys and press [SET] key to set.
- Press [SET] key to check ON/OFF day.

- OFF time setting (AM, PM)
- OFF time setting (Hour, Min.)
- Complete to set



- Select PM by [A] or [V] keys and move the flashing to hour position by [P] key.
- Move the flashing to min. position by [P] key after set 6:00 by [A] or [V] keys and set min. as 10 and press [SET] key to set.
- Press [SET] key to set additional program.

- Weekly Pulse mode

Output2(OUT2) is ON for 10sec at 8:00AM from Monday to Friday during S2 season in case, period of S1, S2, S3, S4 is set.



- Advance to weekly program setting mode
- Mode type setting
- Season selection

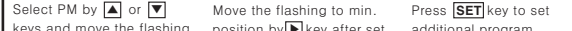

- [MODE] key is pressed over 3sec in RUN mode, [P] is flashed and press [SET] key.
- When PULSE is flashed by press [A] or [V] keys in ON/OFF mode indicator flashing status, press [SET] key to set.
- Press [A] or [V] keys to select season S2 and press [SET] key to set.

- ON day setting
- ON time setting (AM, PM)
- ON time setting (Hour, Min.)

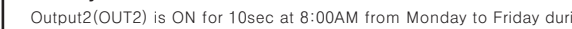

- Press [P] key to move the indicator to Monday, it will be lighted when [A] or [V] keys are pressed and move it to Tuesday by [P] key. Press [SET] key after light Tuesday, Wednesday, Thursday, Friday.
- Press [P] key, move the flashing to hour position and select PM by [A] or [V] keys when ON time is afternoon.
- Set 8:00 by [A] or [V] keys and press [SET] key to set.

- Pulse width setting
- Complete to set

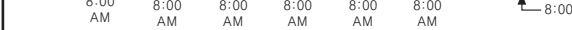

- Press [A] or [V] keys to select pulse width as 10s(10sec) and press [SET] key to set.
- Press [SET] key to set additional program.

Weekly Cycle mode

(Ex)Output1(OUT1) is ON for 10min and OFF for 5min from Monday 6:00AM to Saturday 5:30PM.



- Advance to weekly program setting mode
- Mode type setting
- ~ 8

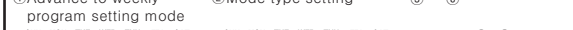

- [MODE] key is pressed over 3sec in RUN mode, [P] is flashed and press [SET] key.
- When CYCLE is flashed by press [A] or [V] keys in ON/OFF mode indicator flashing status, press [SET] key to set.

- ON time width setting
- OFF time width setting
- Complete to set



- Move the flashing to min. position by [P] key and set min. as 10 by press [A] or [V] keys and press [SET] key to set.
- Move the flashing to min. position by [P] key and set min. as 5 by press [A] or [V] keys and press [SET] key to set.
- Press [SET] key to set additional program.

- Weekly day change

When the specified day mode is required to install in other day, it is started from the set day and returned to previous program setting automatically when it is finished.

- Weekly day change cancellation

- Change current year, month, date in current time setting mode
- Change standard day
- Delete all program in program
- Season switching

- Setting

Output is ON on Saturday at 9:00AM and OFF at 12:00PM and it is ON 8:30AM and OFF at 6:00PM from Monday to Friday and the mode of Monday and Tuesday is operated temporarily as Saturday(standard) program.

- Advance to weekly day change mode
- Standard day selection
- Change day selection

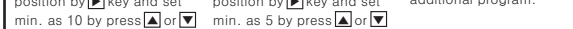

- Press [MODE] key over 3sec to move to the setting group1 in RUN mode and press it repeatedly until "1st DAY" is flashed in second display part and press [SET] key.
- Press [P] key to move the indicator to Saturday and press [SET] key. After select Saturday as standard day(Sat is lighted) by [A] or [V] keys.
- Press [P] key to move the indicator to Monday and select Monday to change (Mon is lighted) by [A] or [V] keys and repeat the procedure to select Tuesday to change(Tue is lighted) and press [SET] key to complete weekly day change setting.

- Yearly holiday mode

It is used to off the output without program adjustment during previously set yearly holiday period available from present year to 31, Dec of the next year.

Designate the start date of yearly holiday and year of end date as every ("--") to repeat the holiday mode for specified in every year.

- Setting

Set every year 5, May to off the output.

- Advance to yearly holiday mode
- Yearly holiday No. display
- Start date of yearly holiday setting



- Press [MODE] key over 3sec to move to the setting group1 in RUN mode and press it repeatedly until "H.dY" is flashed in second display part and press [SET] key.
- Press [SET] key after check yearly holiday No.
- Month position will be flashed by press [P] key and Set May by [A] or [V] keys and date position will be flashed by press [P] key. Set 5th by [A] or [V] keys and press [SET] key to set.

- End date of yearly holiday setting
- Complete to set

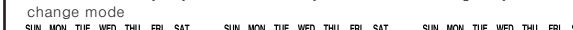

- Month position will be flashed by press [P] key and Set May by [A] or [V] keys and date position will be flashed by press [P] key. Set 5th by [A] or [V] keys and press [SET] key to set.
- Press [MODE] key to finish the additional yearly holiday setting and press [SET] key to set additional program.
- It is able to set yearly holiday up to 12 times.

Yearly program setting

Yearly ON/OFF mode

(Ex)Output(OUT) is ON from every 5, Apr to 7, Apr at 9:00AM and OFF 5:10PM.

- Advance to yearly program setting mode
- Mode type setting
- Start date setting

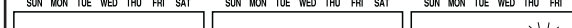

- Press [MODE] key for 3 sec in RUN mode, [P] is flashed and press [MODE] key once, then, [P] and YEAR are flashed and press [SET] key to set.
- Press [SET] key when ON/OFF is flashed.
- Press [P] key until month position is flashed and set Apr by [A] or [V] keys and press [P] key until date position is flashed. Press [SET] key after set 5th by [A] or [V] keys.

- End date setting
- ON time setting (AM, PM)
- ON time setting (Hour, Min.)



- The flashing is moved to month position directly and press [A] or [V] keys and set Apr and press [P] key until date position is flashed. Press [SET] key after set 7th by [A] or [V] keys.
- [P] key is pressed, move the flashing to hour position and select PM by [A] or [V] keys when ON time is afternoon.
- Set 9:00 by [A] or [V] keys and press [SET] key to set.

- OFF time setting (AM, PM)
- OFF time setting (Hour, Min.)
- Complete to set



- Select PM by [A] or [V] keys and move the flashing to hour position by [P] key.
- Move the flashing to minute position by [P] key after set 5 for hour by [A] or [V] keys and press [SET] key after set the minute as 10 by [A] or [V] keys.
- Press [SET] key to set additional program.

- Yearly Pulse mode

(Ex)Output(OUT) is ON from 2, Oct, 2008 to 4, Oct, 2008 at 10:00AM and OFF after 5sec. (Present is 2007.)

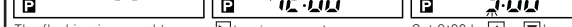

- Advance to yearly program setting mode
- Mode type setting
- Start date setting

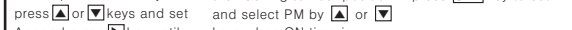

- Press [MODE] key for 3 sec in RUN mode, [P] is flashed and press [MODE] key once, then, [P] and YEAR are flashed and press [SET] key to set.
- When PULSE is flashed by press [A] or [V] keys in ON/OFF mode indicator flashing status, press [SET] key to set.
- Press [A] or [V] keys to set year 2008(08) and move to month position by [P] key. Set Oct by [A] or [V] keys and move to date position by [P] key and press [SET] key after set 2nd by [A] or [V] keys.

- End date setting
- ON time setting (AM, PM)
- ON time setting (Hour, Min.)

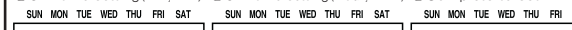

- Move to end month position by [P] key and set 4th by [A] or [V] keys after move to end date position by [P] key and press [SET] key.
- [P] key is pressed, move the flashing to hour position and select PM by [A] or [V] keys when ON time is afternoon.
- Set 10:00 by [A] or [V] keys and press [SET] key to set.

- Pulse width setting
- Complete to set



- Press [A] or [V] keys 4 times to select pulse width as 5s and press [SET] key.
- Press [SET] key to set additional program.

- Yearly Pulse mode

(Ex)Output(OUT) is ON from 2, Oct, 2008 to 4, Oct, 2008 at 10:00AM and OFF after 5sec. (Present is 2007.)

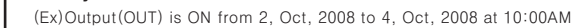

- Advance to yearly program setting mode
- Mode type setting
- Start date setting



- Press [MODE] key for 3 sec in RUN mode, [P] is flashed and press [MODE] key once, then, [P] and YEAR are flashed and press [SET] key to set.
- When PULSE is flashed by press [A] or [V] keys in ON/OFF mode indicator flashing status, press [SET] key to set.
- Press [A] or [V] keys to set year 2008(08) and move to month position by [P] key. Set Oct by [A] or [V] keys and move to date position by [P] key and press [SET] key after set 2nd by [A] or [V] keys.

- End date setting
- ON time setting (AM, PM)
- ON time setting (Hour, Min.)

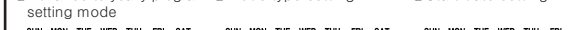

- Move to end month position by [P] key and set 4th by [A] or [V] keys after move to end date position by [P] key and press [SET] key.
- [P] key is pressed, move the flashing to hour position and select PM by [A] or [V] keys when ON time is afternoon.
- Set 10:00 by [A] or [V] keys and press [SET] key to set.

- Pulse width setting
- Complete to set



- Press [A] or [V] keys 4 times to select pulse width as 5s and press [SET] key.
- Press [SET] key to set additional program.

- Yearly Pulse mode

(Ex)Output(OUT) is ON from 2, Oct, 2008 to 4, Oct, 2008 at 10:00AM and OFF after 5sec. (Present is 2007.)



- Advance to yearly program setting mode
- Mode type setting
- Start date setting

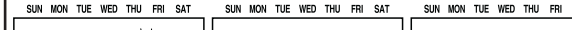

- Press [MODE] key for 3 sec in RUN mode, [P] is flashed and press [MODE] key once, then, [P] and YEAR are flashed and press [SET] key to set.
- When PULSE is flashed by press [A] or [V] keys in ON/OFF mode indicator flashing status, press [SET] key to set.
- Press [A] or [V] keys to set year 2008(08) and move to month position by [P] key. Set Oct by [A] or [V] keys and move to date position by [P] key and press [SET] key after set 2nd by [A] or [V] keys.

- End date setting
- ON time setting (AM, PM)
- ON time setting (Hour, Min.)

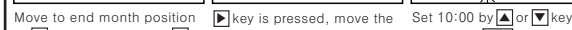

- Move to end month position by [P] key and set 4th by [A] or [V] keys after move to end date position by [P] key and press [SET] key.
- [P] key is pressed, move the flashing to hour position and select PM by [A] or [V] keys when ON time is afternoon.
- Set 10:00 by [A] or [V] keys and press [SET] key to set.

- Pulse width setting
- Complete to set

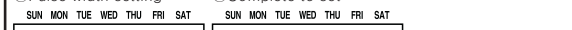

- Press [A] or [V] keys 4 times to select pulse width as 5s and press [SET] key.
- Press [SET] key to set additional program.

- Yearly Pulse mode

(Ex)Output(OUT) is ON from 2, Oct, 2008 to 4, Oct, 2008 at 10:00AM and OFF after 5sec. (Present is 2007.)

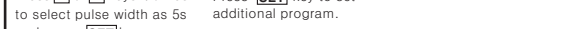

- Advance to yearly program setting mode
- Mode type setting
- Start date setting

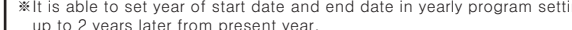

- Press [MODE] key for 3 sec in RUN mode, [P] is flashed and press [MODE] key once, then, [P] and YEAR are flashed and press [SET] key to set.
- When PULSE is flashed by press [A] or [V] keys in ON/OFF mode indicator flashing status, press [SET] key to set.
- Press [A] or [V] keys to set year 2008(08) and move to month position by [P] key. Set Oct by [A] or [V] keys and move to date position by [P] key and press [SET] key after set 2nd by [A] or [V] keys.

- End date setting
- ON time setting (AM, PM)
- ON time setting (Hour, Min.)



- Move to end month position by [P] key and set 4th by [A] or [V] keys after move to end date position by [P] key and press [SET] key.
- [P] key is pressed, move the flashing to hour position and select PM by [A] or [V] keys when ON time is afternoon.
- Set 10:00 by [A] or [V] keys and press [SET] key to set.

Program check, modify and delete

Weekly program check, modify and delete

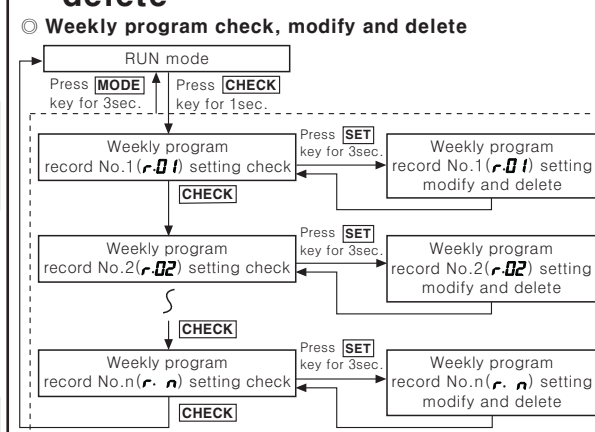

Yearly program check, modify and delete

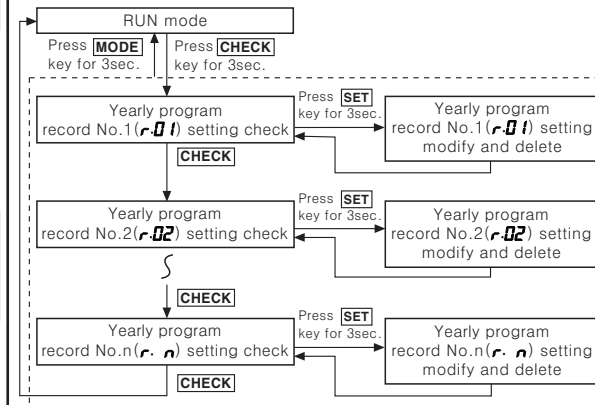

* "YEAR" is lighted when check, modify or delete yearly program.

- If any key is untouched for 60sec, it is returned to RUN mode in weekly or yearly program check.
- In weekly or yearly program check, it controls output depending on program setting and output is OFF in modify or delete mode.
- When [MODE] key is pressed in weekly or yearly program record modify, delete stand by or delete mode, current work is cancelled and it is returned to check mode.
- Weekly or yearly program record modify and delete
 - Program record modify
 - When press [SET] key over 3sec in program check, "Edt" is flashed in second display part, press [SET] key.
 - It is returned to check mode when finish the modify same as the above procedure.
 - Program record delete
 - When press [SET] key over 3sec in program check, "Edt" is flashed in second display part, press [A] or [V] keys until "CLr" is flashed in second display part and press [SET] key.
 - Press [SET] key over 3sec when "CLr" is lighted in second display part, it is returned to program check.

Caution for using

- Please use within the rated power and apply or cut the power at once to prevent from chattering.
 - Please insulate this unit from the circuit of control panel.
 - Please make all terminals of this unit short-circuited.
- When control a heater, please install the thermostatic switch at load circuit.
- Installation environment
 - It shall be used indoor
 - Altitude Max. 2000m
 - Pollution Degree 2
 - Installation Category II.

* It may cause malfunction if above instructions are not followed.

Major products

- Proximity sensors
- Photoelectric sensors
- Area sensors
- Fiber optic sensors
- Door/Door side sensors
- Pressure sensors
- Counters
- Timers
- Rotary encoders
- Display units
- Power controllers
- Sensor controllers
- Panel meters
- Graphic/Logic panels
- Temperature controllers
- Tachometer/Pulse(Freq) meters
- Temperature/Humidity transducers
- Switching power supplies
- Stepping motors/drivers/motion controllers
- Field network devices
- Laser marking system (CO₂, Nd:YAG)
- Laser welding/soldering system

Autonics Corporation